

Alpha TR



AUXILIARY | TRIPPING | SUPERVISION | PILOT WIRE

High Speed Tripping Relay

High performance electro-mechanical tripping relays for power utility protection and control applications.

- > ANSI 86
- > <8ms operate time
- > Draw out case
- > Flush panel or rack mount
- > Wide range of functions and options
- > US Patent – US 8,115,578 B2
- > Made in Australia



Alpha TR Series

The Alpha TR Series represents a new generation of high speed electro-mechanical tripping relays for power utility protection and control applications.

The TR is built on the Alpha relay platform and provides high performance and reliability while reducing production and supply lead times.

Application of the TR multi-contact high-speed trip relays ensures fast operation of less than 8 ms. The unique patented design and topology ensures minimal contact bounce.

Model Designation

Five (5) contact version: TR5

Twelve (12) contact version: TR12

Front Panel Layout



Figure 1:

Front panel layout depicting flags, resets & option positions
 The flag and reset positions for the five contact TR5 version are set lower on the front panel.



Application

The effect of a fault on a power system is dependent on the speed with which the fault can be detected and isolated. Modern protection schemes incorporate ever increasing functionality through the application of digital techniques to protection relay technology. The requirement for highly reliable tripping and control relay elements does however remain and often constitutes a significant cost and space requirement when considering protection panel designs. The Alpha TR system fulfils this need by providing a compact, flexible and high-performance solution, while at the same time reducing the cost and lead times normally associated with this class of device.

Features

- > <8ms operate time
- > User selectable low or high burden operation
- > Complies with ESI 48-4 for high burden operation meeting the requirements of capacitor discharge test
- > Rugged modular construction
- > High reliability double action contacts for high operate speed and low bounce
- > 5 or 12 heavy duty contacts available in a wide range of Make and Break combinations
- > Self-reset, hand reset and hand/electrical reset versions
- > Electrical reset interlock
- > High visibility electro-mechanical flag indication
- > Rated operate voltages available for 30/32, 48, 110, 125, 220, 240 or 250 Volts DC nominal auxiliary supplies
- > M4 screw terminals
- > Optional relay operate LED
- > Optional trip counter
- > Optional electrical reset isolation switch
- > Simple to specify and order

Alpha TR

The Alpha TR relay provides the interface between the protection system, the circuit breaker and control equipment.

The application of the Alpha TR multi-contact high-speed trip relays ensures fast operation of less than 8 ms. The unique patented design and topology ensures minimal contact bounce.

A wide voltage operating range and user selectable low or high burden tripping relay operation reduces the number of model variations. The TR range is packaged in a draw out case system and can be either flush panel or rack mounted.

For applications requiring a maximum of five contacts, refer to the ordering section to specify this version.

Where more than 12 contacts are required refer to the 6R MATRIX system Technical Bulletin.

Construction

The Alpha Series represents a new generation of electro-mechanical relays designed specifically for application where high performance and reliability is paramount. While the fundamental and proven electro-mechanical mechanism has been maintained, the implementation of modern manufacturing techniques combined with an innovative architecture has provided a very flexible and competitive alternative to older generation auxiliary relays.

Figure 2 provides a snap shot of the major design innovations incorporated in the Alpha Series. Patent pending - 2007272292.

Inspection of the contacts is possible by drawing out the relay module from the case as shown in figure 3. The contacts, while protected and isolated at the rear terminal block of the module are readily visible so that they can be checked for any sign of burning, pitting or overheating.

Manual operation of the contacts is also possible with the module removed from the case. This allows checking of the contact alignment and over travel.

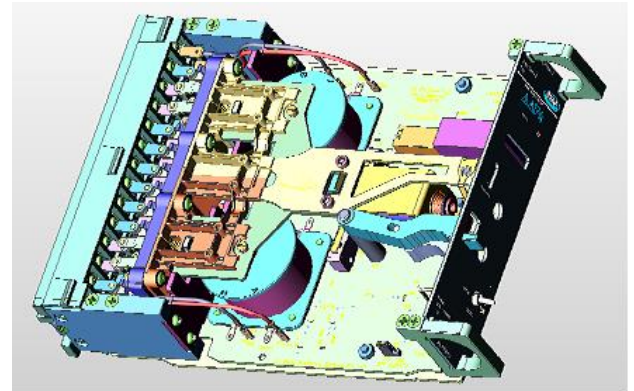

Figure 2: Alpha TR12 module construction (Fiberglass side plate removed for clarity)

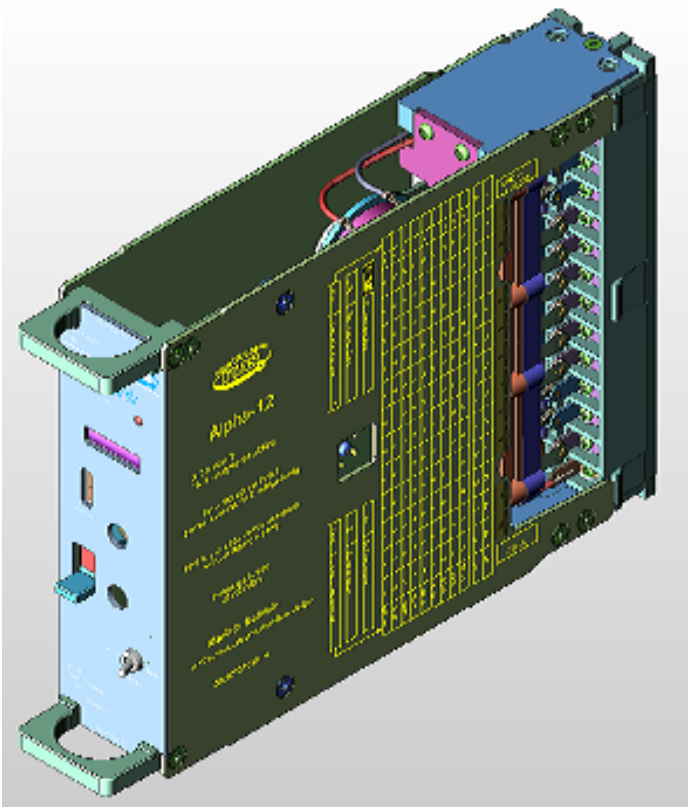

Figure 3: Alpha TR12 module depicting contact inspection window and terminal wiring chart

Electrical Reset Inhibit Switch

A front panel switch is available as an option to allow a local operator to isolate the electrical reset coil and disable the remote reset function. Care should be taken to ensure that this switch is not operated in the presence of a reset signal. Refer ordering code section.

Electrical Reset Interlock

Depending on overall protection scheme design, standard protection relays can be wired into a configuration where a 'race' condition is possible. If the reset circuit is held energized while the relay operate input also remains energized, the relay will oscillate between operated and reset states. The reset interlock feature eliminates this condition and protects the relay by locking out the reset command in the presence of a relay operate voltage.

Note: This feature adds a 1W burden after pick up to latching, 'zero burden' models.

Where this additional burden is not desirable the user can change a setting link to disable the electrical reset interlock function as depicted in figure 4.

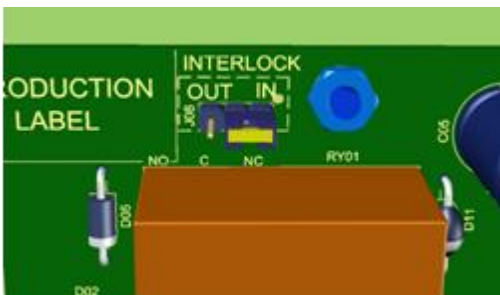

Figure 4: Configuration link for the Electrical Reset Interlock

The link is shown fitted in the 'IN' position.

IN	=	Electrical Reset Interlock in service
OUT	=	Electrical Reset Interlock out of service

The electrical reset interlock configuration setting link is located at the top front of the draw out module and is readily accessible to the user for checking and setting to meet specific system requirements. Unless otherwise specified all electrical reset relays are factory set to the 'IN' position.

Contact Operation

The Alpha TR relay contacts can be specified to reset in a number of ways:

Self-Reset Contacts

All contacts operate when a voltage in the specified range is applied to the relay coil and reset when this voltage is removed.

Hand Reset Contacts

All contacts operate and mechanically latch when a voltage in the specified range is applied to the relay coil and reset when the reset button located on the front of the relay is pressed.

Electrical and Hand Reset Contacts

All contacts operate and mechanically latch when a voltage in the specified range is applied to the relay coil and reset when the reset button located on the front of the relay is pressed. A voltage applied to the reset coil may also be used to reset the contacts.

Electrical Reset Contacts

All contacts operate and mechanically latch when a voltage in the specified range is applied to the relay coil and reset when a voltage applied to the reset coil.

Manual Reset Mechanism

For relays specified with manual reset functions, a reset mechanism is provided on the front panel and cover. Manual reset can be accomplished with the front cover fitted or removed.

Care should be taken to avoid holding the Contact and Armature Flag Hand Reset actuator in the reset position during the presence of a relay operate signal. This action will cause the relay to oscillate between drop-out and pick-up and if this condition is maintained may result in thermal and / or mechanical damage to the device.

Flag Indicators

The Alpha TR relay offers two types of mechanical flags (Armature and independent reset types available). These consist of a high visibility; solid, day glow orange indicator which become visible on energization of the relay coil. The relay can be ordered with either, both or no flags fitted.

Note: There is no impact on the contact operate speed or relay performance when these flags are fitted.

Armature Flag

The armature flag is connected to the relay armature and therefore always indicates the position of the contacts. The standard armature flag becomes visible when the relay is operated. If latching contacts are specified, the self-reset flag will remain visible in the latched condition until the relay is reset.

Independent Hand Reset Flag

This flag is independent of the self-reset flag and operates when the contacts are first operated and remains visible until it is manually hand reset using the reset button located on the front of the relay. Note that this flag can only be reset once the relay has been reset.

Coil Operation LED

An optional front panel LED may be specified to indicate when a voltage is applied to the operate coil terminals. This feature can be useful during commissioning particularly for latching relays and where armature flags are not fitted to indicate the operate voltage status. Refer ordering code section.

Operation Counter

An optional 6-digit operation counter is available to record the number of contact pick up events. The displayed count cannot be reset.

Operation of Series Elements

External relay elements are sometimes employed for additional flagging and alarm functions. These elements are typically much slower than the primary high-speed tripping relay so care must be taken to ensure reliable operation of all series element before the series trip signal is cut off or economized. The incorporation of a standard 50 ms time delay feature in the TR relay provides for such circumstances.

To ensure adequate current is available to operate the series devices, the TR relay should be configured for high burden operation.

Low Burden Setting

The low burden configuration is suitable for applications where immunity to capacitance discharge and high minimum operation currents are not required. Suitable for MV applications where the DC battery supply capacity is limited.

High Burden Setting

In this configuration the relay is suitable for application in high security circuit breaker tripping circuits and in particular where the initiating contact may be remote from the relay. The high burden can also be used to facilitate the satisfactory operation of external series elements - Refer to the section 'Operation of Series Elements'.

The high burden configuration provides maximum immunity to electrical disturbance and noise.

High burden tripping relays are designed to withstand the 10uF capacitor discharge test such that the relay will not operate when a 10uF capacitor charged to 120% of the nominal operating voltage is applied across the operate input of the relay.

Operating Burden Configuration

The Alpha TR high speed tripping relays may be set by the user for low burden or high burden operation. This is achieved by withdrawing the relay module from the case and changing the position of a PCB link, as depicted in figure 5.

The burden setting link is located at the bottom front of the draw out module and is readily accessible to the user for checking and changing to meet specific system requirements.

Unless otherwise specified all TR model relays are factory set and shipped in high burden configuration.

The link is shown fitted in the low burden (LB), position.

LB = Low burden operation.

HB = High burden operation – default factory position.



Figure 5: Link for setting operating burden

Contact Performance

Contact bounce can present a problem in modern protection schemes where high speed status inputs are used for signalling purposes. Contact bounce can lead to multiple events being initiated.

A prominent factor in contact bounce is the kinetic energy of the contacts resulting from the high speed of operation and mass of the heavy-duty contacts employed. To minimize bounce this energy must be dissipated. In the TR this is achieved through the damping effect of the contact over travel action (Refer self-cleaning contacts section) and specially designed speed shaping of the armature action.

The effectiveness of this method is enhanced by the double make contact geometry which allows the contact travel to be approximately halved without a reduction in the kV isolation across the open contact pairs. This has the effect of reducing the terminal velocity of the moving contacts and in turn the kinetic energy to be absorbed by the contact wiping action allowing a clean contact make with minimal bounce.

The timing trace depicted in figure 6 is a representative example of a high-speed contact operation showing first contact touch at 8 ms and a bounce duration of 1 ms. Refer to the Contact Bounce section under General Specifications for further details on this important performance characteristic.

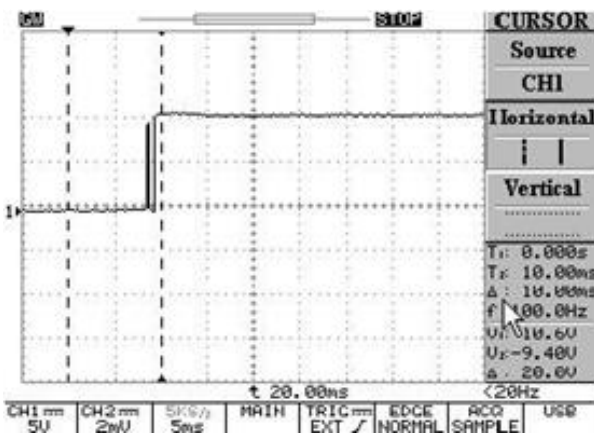

Figure 6: High speed contact operation (5 ms per division)

Self-Cleaning Contacts

Contacts are constructed from silver / copper alloy, specially shaped and positioned to ensure very reliable, low resistance operation. Over travel of the contacts during each operation causes a wiping action ensuring a clean 'make' with minimal bounce.

Gold Plated Contacts

Gold plated contacts are available as an option for very low current switching. Refer ordering code section.

Standard Contact Configuration

TR5 Contact Version

4 N/O make (M) contacts plus 1 N/C break (B) contact

Alternative contact arrangements from 5M+0B to 1M+4B can be specified in the ordering information section. Contact terminal assignments are defined in table 1.

TR12 Contact Version

8 N/O make (M) contacts plus 4 N/C break (B) contacts

Alternative contact arrangements from 06M+06B to 10M+02B can be specified in the ordering information section. Contact terminal assignments are defined in table 2.

Double Make / Double Break Contacts

Each contact is made up of a double make or double break geometry to increase the isolation between open contacts and increase the current break rating.

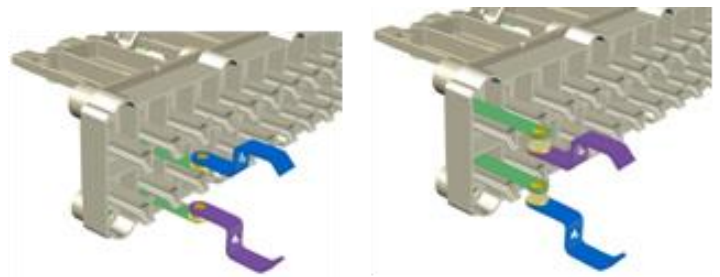

Figure 7: Contact geometry

This geometry also removes the need for internal wiring between case terminals and the relay contacts. This results in four (4) less electrical terminations per contact providing increased system security.

Operating Time

Make contacts: <8 ms to first touch and <9 ms to end bounce at nominal rated operating voltage.

Break contacts: <8 ms transition

Operating Burden

ESI 48-4 2010 Table 1 - Low and high burden

Trip burden during pick-up at nominal	
Low burden setting	50 W maximum
High burden setting	100 W minimum 150 W maximum

Electrical Reset Burden (where fitted)		
	Voltage	Burden
	32V dc	<25W
	48V dc	<60W
	110V dc	<30W
	125V dc	<40W
	220V dc	<50W
	240V dc	<60W
	250V dc	<65W

Operated Burden

Burden after relay economization at nominal				
Voltage	Self reset Contacts	Latching Contacts	Additional burden for LED and or Counter	Additional burden for Elec Reset Interlock
32V dc	<5W	<0.12W	<0.5W	<1W
48V dc	<5W	<0.18W	<0.5W	<1W
110V dc	<5W	<0.40W	<1W	<1W
125V dc	<5W	<0.45W	<1W	<1W
220V dc	<5W	<0.80W	<2W	<1W
240V dc	<5W	<0.88W	<2W	<1W
250V dc	<5W	<0.90W	<2W	<1W

Minimum Operating Current

Low burden setting	50 mA minimum
High burden setting	100 mA minimum

Time Delayed Cut Off

Economizing delay	50 +/- 10 ms
-------------------	--------------

Operating Voltage Range

Guaranteed operation between 50% and 120% of nominal rated DC operating voltage.

For 30/32 V DC rated models the operating range is from 50% of the lower rating to 120% of the higher rating.

Note: The 50% of nominal value allows for correct operation of the relay even when there is a loss of battery charger supply for considerable periods.

To ensure guaranteed operation at 50% of nominal voltage the relay is manufactured to operate at a lower level to guarantee operation if the voltage falls to 50% of nominal voltage. Consequently, it will be found that these relays will operate below 50% of nominal voltage to allow for manufacturing tolerance on devices, this is normal and correct and does not affect relay stability.

The 50% of nominal voltage figure does not indicate the relay pickup voltage.

Reset Voltage

Self-reset relays will reset at not less than 5% of nominal rated operate voltage. Reset typically occurs at 20% of nominal.

Coil Thermal Rating

All operate, reset and time delayed circuits are designed to withstand continuous application of 120% of the nominal rated voltage.

The high speed operate coil element (150 W max.) has a thermal rating of 30 seconds, however the TR tripping relays automatically economizes within 60 ms of operation to provide inherent thermal protection.

Electrical Reset Relays

Reset voltage: As per operating voltage range.

Reset cut off: Instantaneous with main relay reset.

Contact Ratings

Operating Voltage	Voltage free
Isolation across open contacts	1 kV rms
Make and carry: Continuous	1,250 VA AC resistive 1,250 W DC resistive Limited at both 660 V and 8 A
Make and carry for 3s	7,500 VA AC resistive 7,500 W DC resistive Limited at both 660 V and 30 A
AC break capacity	1,250 VA AC resistive Limited at both 8 A and 250 V
DC break capacity	100W DC resistive 50W DC inductive Limited at both 8 A and 250 V

Insulation

Standard	IEC 60255-5	
Type	Level	
Any Terminal and Earth	2.0kV ac rms for 1min	
	5.0kV 1.2/50us 0.5J	
Between Independent Circuits	2.0kV ac rms for 1min	
	5.0kV 1.2/50us 0.5J	
Across Normally Open Contacts	1.0kV ac rms for 1min	

High Frequency Disturbance

Standard	IEC 60255-22-1	
Type	Level	Variation
Common (Longitudinal)	2.5kV	≤5%
Differential (Transverse)	1.0kV	≤5%

Electrostatic Discharge

Standard	IEC 60255-22-2 Class 3	
Type	Level	Variation
Contact Discharge	8.0kV	≤5%

Fast Transients

Standard	IEC 60255-22-4 Class A	
Type	Level	Variation
5/50ns 100kHz	4.0kV	≤5%

Surge Immunity

Standard	IEC 60255-22-5	
Type	Level	Variation
Between all Terminals and Earth	4.0kV	≤10%
Between any Two Independent Circuits	2.0kV	

Capacitor Discharge

Standard	ENA TS 48-4 2010 ISSUE 4	
Nominal voltage	Capacitor discharge test compliance	
32 V dc	Not applicable	
48 V dc	TR relays set for high burden Operation. Refer figure 4.	No mal op. for Capacitor discharge: C = 10 uF V = 120% of Vnominal (* 275V Maximum)
110 V dc		
125 V dc		
230 V dc *		
240 V dc *		
250 V dc *		

Temperature

Standard	IEC 60068-2-1/2
Operating Range	-10 to +55 degrees Celsius
Storage Range	-25 to +70 degrees Celsius

Humidity

Standard	IEC 60068-2-78
Operating Range	40 degrees Celsius and 93% RH non-condensing

IP Rating

Standard	IEC 60529
Installed	IP5x

Vibration - Sinusoidal

Standard	IEC 60255-21-1 Class I	
Vibration Response	0.5gn	≤5%
Vibration Endurance	1.0gn	≤5%

Shock and Bump

Standard	IEC 60255-21-2 Class I	
Shock Response	5gn, 11ms	≤5%
Shock Withstand	15gn, 11ms	≤5%
Bump Test	10gn, 16ms	≤5%

Seismic

Standard	IEC 60255-21-3 Class I	
Seismic Response	1gn	≤5%

Mechanical Classification

Durability - 0.1 Hz maximum repetition rate	>10 ⁵ operations at no load
	>10 ⁴ operations at full load

Terminal Layout

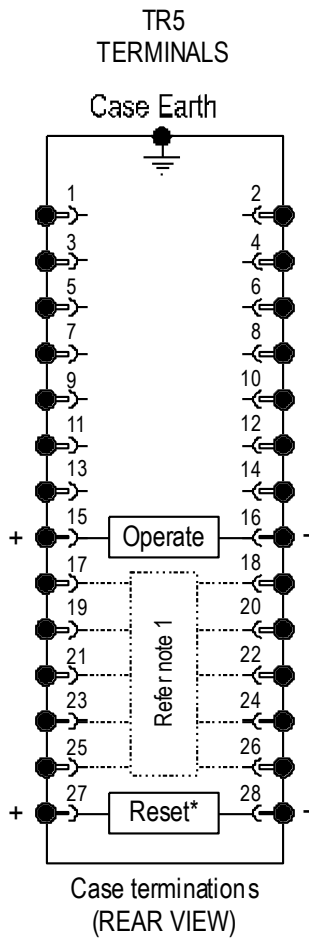

Figure 10: TR5 rear terminal layout

* Electrical reset only fitted where specified

Note: Refer contact configuration code & wiring table 1

Standard Wiring Configuration

The case termination diagrams in figure 10 depicts the rear screw terminals and position of the operate and reset coils for the TR5 version. Note the connection polarity for correct DC operation.

	Terminals	
Operate coil	15+	16-
Reset coil	27+	28-

The contact function between each pairs of terminals is determined by the order code selected.

M Normally open Make (M) contact

This contact closes when the relay operate coil is energized.

B Normally closed Break (B) contact

This contact opens when the relay operate coil is energized.

Table 1 provides the terminal wiring assignment for each of the contact configurations available with the TR5 relay version.

This wiring table is also printed on the side panel of the draw out module for easy reference in the field.

Contact Configuration	TR5 Case Terminal Number Pairs				
	17-18	19-20	21-22	23-24	25-26
N	5M+0B	M	M	M	M
P	4M+1B	M	M	M	B
Q	3M+2B	B	M	M	B
R	2M+3B	B	M	M	B
S	1M+4B	B	B	M	B

Table 1

Terminal Layout

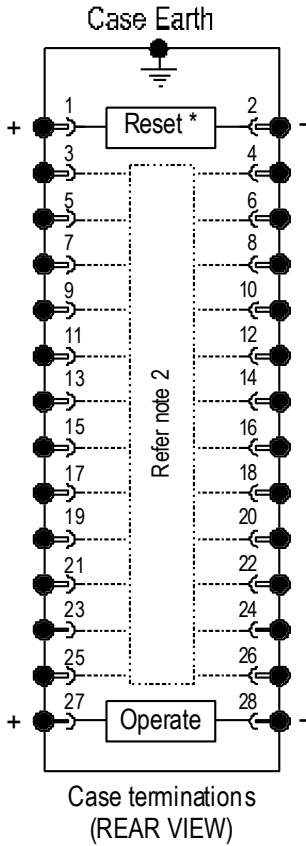

Figure 11: TR12 rear terminal layout

* Electrical reset only fitted where specified

Note: Refer contact configuration code & wiring table 2

Standard Wiring Configuration

The case termination diagrams in figure 11 depicts the rear screw terminals and position of the operate and reset coils for the TR12 version. Note the connection polarity for correct DC operation.

	Terminals	
Operate coil	27+	28-
Reset coil	1+	2-

The contact function between each pairs of terminals is determined by the order code selected.

M Normally open Make (M) contact

This contact closes when the relay operate coil is energized.

B Normally closed Break (B) contact

This contact opens when the relay operate coil is energized.

Table 2 provides the terminal wiring assignment for each of the contact configurations available with the TR12 relay version.

This wiring table is also printed on the side panel of the draw out module for easy reference in the field.

Contact Configuration	TR12 Case Terminal Number Pairs											
	3-4	5-6	7-8	9-10	11-12	13-14	15-16	17-18	19-20	21-22	23-24	25-26
C 10M+02B	B	M	M	M	M	M	M	M	M	M	M	B
D 09M+03B	B	M	M	M	M	M	M	M	M	M	B	B
E 08M+04B	B	B	M	M	M	M	M	M	M	M	B	B
F 07M+05B	B	B	M	M	M	M	M	M	M	B	B	B
G 06M+06B	B	B	B	M	M	M	M	M	M	B	B	B

Table 2

Case Construction

The outer case is manufactured from zinc coated mild steel providing considerable strength and long term durability. The entire case surface is powder coated to provide corrosion protection and an attractive textured finish. Relay elements are mounted on fabricated fiberglass and acetal components to provide reliable electrical isolation.

M Series Draw Out Case

The M Series case range has been specifically designed to meet the demanding and varied requirements for applications in power utility sub-station environments. The standard 4U high 19-inch rack mounting modular configuration simplifies panel design and installation.

Mounting points and overall panel dimensions meet international standards such that the cases may be interchanged with other similar types available. Refer to the M Series Technical Bulletin for additional information on case mounting and wiring.

Front View

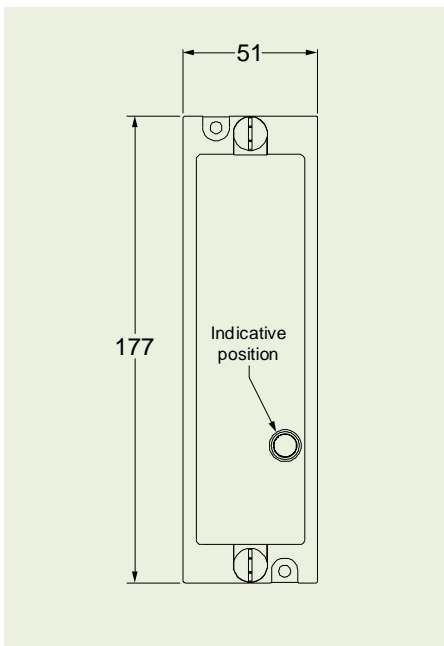

Rear View

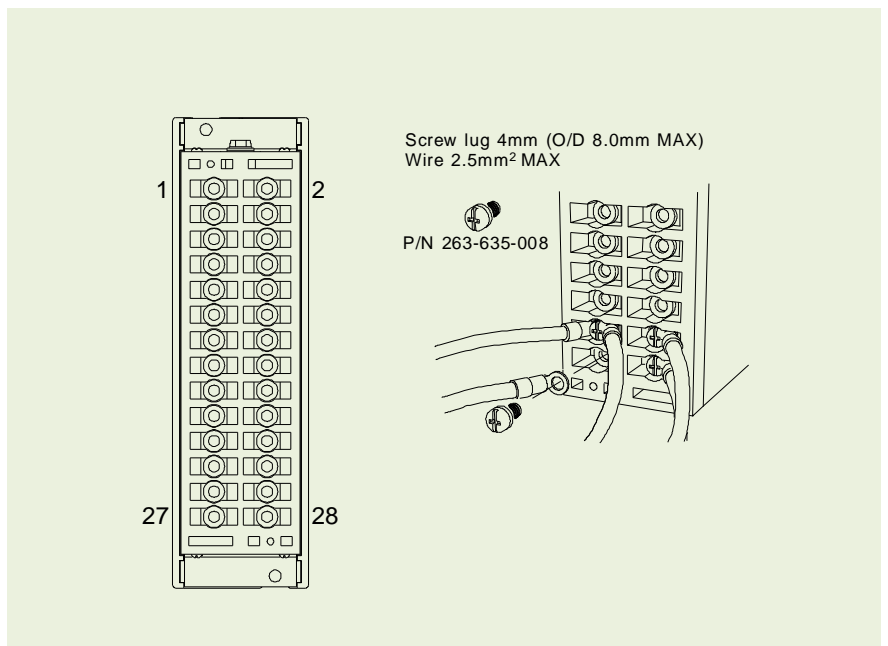

Panel Cut-out

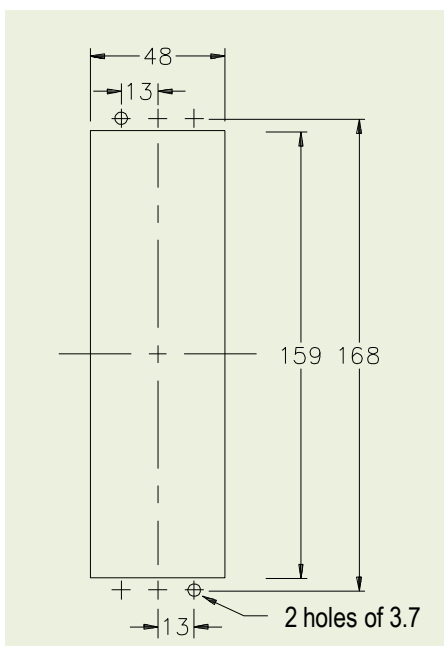

Side View

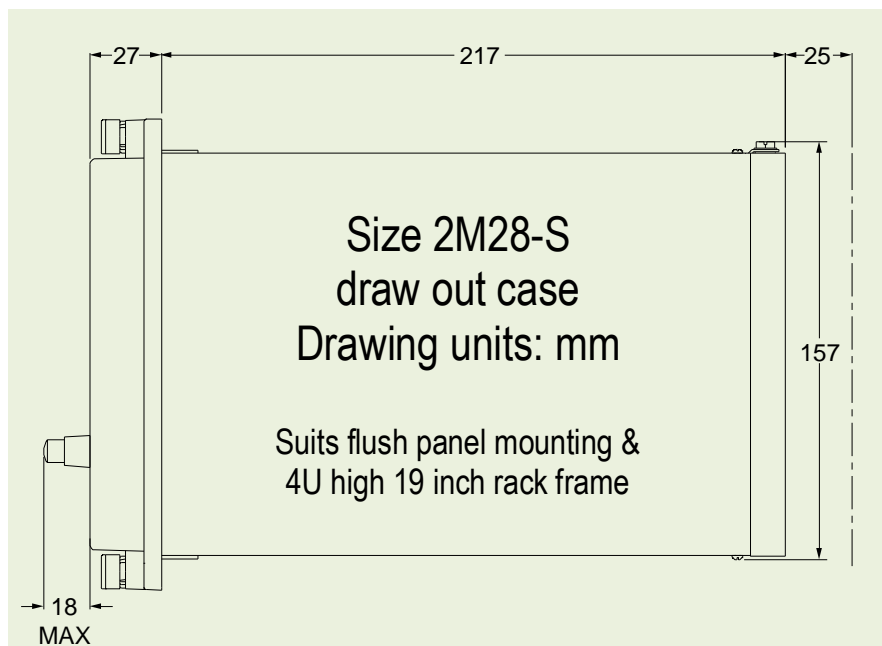

Alpha TR5 Relay Order Code

TR5 -						
Nominal Operate Voltage	B				32 V dc	
	C				48 V dc	
	D				110 V dc	
	E				125 V dc	
	F				220 V dc	
	G				240 V dc	
	H				250 V dc	
	Contact Configuration	N				5 Make + 0 Break
P					4 Make + 1 Break	
Q					3 Make + 2 Break	
R					2 Make + 3 Break	
S					1 Make + 4 Break	
Contact Function		1			Self-reset contacts	
		2			Latching contacts	Hand reset
		3			Latching contacts	Electrical reset
		4			Latching contacts	Hand and electrical reset
Flag Function			1		Armature flag	Flag resets with contacts
			2		Hand reset flag	Flag resets with front panel reset
			3		Both flags fitted	Refer order codes 1 and 2
			4		No flags fitted	
Options				-	No options required	
				C	Operation counter	
				G	Gold plated contacts	
				L	Coil operation LED	
				S	Electrical reset inhibit switch	

Cross Reference

	Alpha TR Code
MVAJ11-5, 051	TR5-00-12
MVAJ13-5, 053	TR5-00-22
MVAJ14-5, 054	TR5-00-32
MVAJ15-5, 055	TR5-00-42
MVAJ21-5, 051	TR5-00-12
MVAJ23-5, 053	TR5-00-22
MVAJ24-5, 054	TR5-00-32
MVAJ25-5, 055	TR5-00-42

Alpha TR12 Relay Order Code

TR12 -						
Nominal Operate Voltage	B				32 V dc	
	C				48 V dc	
	D				110 V dc	
	E				125 V dc	
	F				220 V dc	
	G				240 V dc	
	H				250 V dc	
	Contact Configuration	C				10 Make + 02 Break
D					09 Make + 03 Break	
E					08 Make + 04 Break	
F					07 Make + 05 Break	
G					06 Make + 06 Break	
Contact Function		1			Self-reset contacts	
		2			Latching contacts	Hand reset
		3			Latching contacts	Electrical reset
		4			Latching contacts	Hand and electrical reset
Flag Function			1		Armature flag	Flag resets with contacts
			2		Hand reset flag	Flag resets with front panel reset
			3		Both flags fitted	Refer order codes 1 and 2
			4		No flags fitted	
Options				-	No options required	
				C	Operation counter	
				G	Gold plated contacts	
				L	Coil operation LED	
				S	Electrical reset inhibit switch	

Cross Reference

	Alpha TR Code
MVAJ11-10, 101	TR12-00-12
MVAJ13-10, 103	TR12-00-22
MVAJ14-10, 104	TR12-00-32
MVAJ15-10, 105	TR12-00-42
MVAJ21-10, 101	TR12-00-12
MVAJ23-10, 103	TR12-00-22
MVAJ24-10, 104	TR12-00-32
MVAJ25-10, 105	TR12-00-42



RMS Mors Smitt
A Wabtec company

www.rmspl.com.au



Relay Monitoring Systems Pty Ltd design, manufacture and market a wide range of electrical protection and control products for application on high voltage power systems. The company's depth of manufacturing and engineering expertise is backed up by many years of experience since the formation of its predecessor, Relays Pty Ltd (RPL), in 1955. This experience combined with a broad base of field proven product types enables RMS to service specific customer needs by producing relays on demand and with typically short lead times.

Relay Monitoring Systems Pty Ltd

6 Anzed Court
Mulgrave, Victoria 3170
AUSTRALIA
Ph: +61 3 8544 1200
Fax +61 3 8544 1201
Sales: rms@rmspl.com.au
www.rmspl.com.au
www.relays.com.au

ISO9001 Quality Accreditation

RMS holds BSI (British Standards Institute) registration number 6869 for the certification of a quality system to AS/NZS ISO9001:2008.

Due to RMS continuous product improvement policy the information contained in this document is subject to change without prior notice.

© 2016 Relay Monitoring Systems Pty Ltd

ABN 76 052 484 483