

## /// Plug-in railway relay with 4 C/O contacts

Rugged plug-in relays for extreme reliability, within long endurance applications and harsh environments

### TDE4N-UN

Timer relay

Part of D-platform



### Features

- Time delay relay, delay on drop-out
- No auxiliary power supply necessary
- Compact plug-in design, 4 C/O contacts
- Delay time adjustable by lockable knob
- Also available with fixed time delay
- Total time delay range: 0 s...180 s
- Magnetic arc blow-out ensuring long contact life
- Back EMF suppression diode
- One LED for voltage presence, red or green
- Minimum switching current 1 mA
- Maximum continuous current 10 A
- Wide temperature range -40 °C...+70 °C
- Mechanical life > 30 million operations
- Electrical life e.g. > 10 million operations at 0.5 A, 24 VDC
- Data matrix code with serial number for traceability
- Integrated snaplock, no external retaining clip needed
- Transparent cover for visual inspection
- Many options and sockets available

### Description

Plug-in electronic railway timer relay with four change-over contacts for reliable switching of very low currents (1 mA @5 VDC) up to currents of 10A @ 110VDC. When the relay is de-energized there is a delay on drop-out without any auxiliary power supply. The delay time is adjustable with a lockable knob. The relay can also be supplied with a fixed time delay (no knob).

The relay is equipped with one LED which indicates the presence of power supply.

The built-in magnetic arc blow-out ensures adequate DC breaking capacity resulting in long contact life. The integrated contact separation prevents cross pollution of contacts. On the relay cover the serial number and data matrix code are shown for ease of traceability.

The construction of the relay and choice of materials makes the TDE4N-UN relay suitable to withstand low and high temperatures, shock & vibration and dry to humid environments.

No external retaining clip needed as integrated 'snap-lock' will hold relay into socket under all circumstances and mounting orientations.

Compact design, choice of many options and a wide range of sockets makes the TDE4N-UN relay an easy and flexible solution to use.

### Application

The TDE4N-UN is used in applications where a time delay on drop-out is necessary after de-energizing the relay, without using auxiliary supply. Relays continue to play a vital role in reliable train operation. Key functions are galvanic isolation between control (computers/ PLC's) and power circuits providing system isolation, contact multiplication and amplification.

Other unique features are:

- predictable failure behavior (Fail Safe) making system safety validation a lot more simple than using computer based solutions like PLC's
- long term availability (no obsolescence)
- easy maintenance by plug-in feature and transparent cover
- unlike more sensitive electronics, relays are insensitive to EMI

Using these features one can build a hardwired, fail safe control system which is cyber secure and insensitive to electro magnetic disturbances and surges. Relays are ideal to use in trains for signal transfer/repeat, safety interlocking functions (brake - doors), load on-off switching and sub-system isolation.

### Railway compliancy

EN 50155: 2017	EN 50121-3-2: 2016
IEC 60571: 2012	EN 45545-2: 2015
IEC 60947-5-1: 2016	NF F16-101/102
IEC 61373: 2010	IEC 60947-5-4: 2002



## Timer relay TDE4N-UN

### Options

- Gold plated contacts
- IP50 dust protection
- LED indicator **green** or **red**
- AgSnO<sub>2</sub> contacts, weld resistant for capacitive loads
- AC/DC coil
- Double zener diode
- Double make/double break contacts
- Keying (coding relay to correct socket)

Remark: Not all combinations possible

### Dimensions (mm)

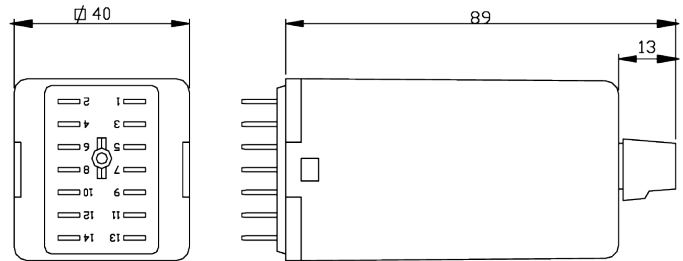

### Timing diagram

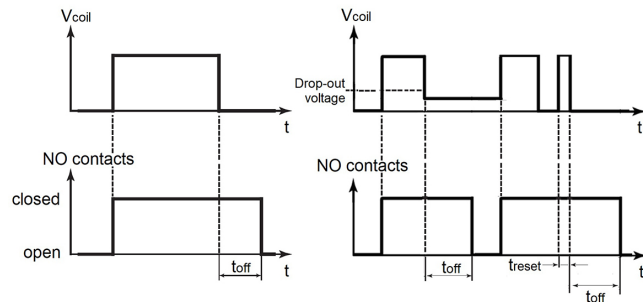

### Weight

~ 190 g

### Serializing

Each relay is marked with a unique serial number to which link important information and test results.

The GTIN (Global Trade Item Number) and part number are printed on each relay in both text and data matrix code according the worldwide recognized GS1 standard, being able to scan each relay for logistical and traceability purposes.

### Connection diagram

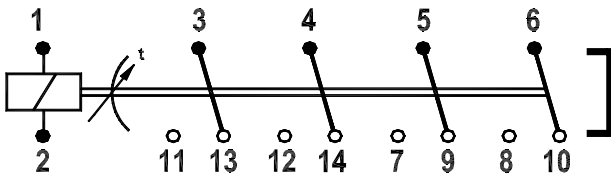

Please note the relay will leave production in open state (with open armature) with all contacts in the position shown in the connection diagram. Due to severe shocks far exceeding maximum levels mentioned in IEC 61373 (Category I, Class B, Body mounted), it can happen the armature closes and stay closed.

Therefore after installation all relays must be checked on correct state of the contacts and apply rated voltage to the coil to check correct operation.

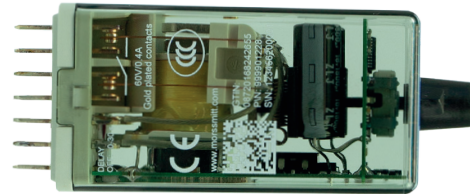

### Sockets

		Mounting			
		Surface / Wall	35 mm rail	Panel / Flush	PCB
Terminal connection	Screw	V23	V23	-	-
	Screw - wide terminals	V22 BR	V23 BR	-	-
	Spring clamp	V29	V29	V33	-
	Faston	-	-	V31	-
	Crimp	-	-	V26	-
	Solder tag	-	-	V3	-
	PCB	-	-	-	V32

For more information see the respective datasheets

 Over 10 million Mors Smitt relays in use in rail transport applications worldwide!

## Technical specifications

### Time delay characteristics

Time delay function		Delay on drop-out (without auxiliary power supply), delay starts when drop-out value is reached.
Available time ranges	Fixed Adjustable	Any value between 0...180 s with resolution of 0.1 s 0-1 s    0-3 s    0-6 s    0-10 s    0-30 s 0-60 s    0-100 s    0-180 s Other time ranges on request
Accuracy	Adjustable time  Adjustable time, pre-set in factory Fixed time	Maximum deviation between visual setting of the knob and set time is $\pm 8\%$ of full scale value Maximum deviation $\pm 4\%$ of full scale value Maximum deviation $\pm 0.5\%$ of fixed time
Repeatability	Adjustable time Fixed time	Maximum deviation $\pm 2\%$ of set time $\pm 50$ ms Maximum deviation $\pm 0.5\%$ of fixed time $\pm 50$ ms
Time variation	vs. voltage variation vs. temperature variation	$\pm 0.1\%$ / % Unom of set value $\pm 0.02\%$ / K deviation from 20 °C
Recovery time		0 s
Pull-in time		< 100 ms
Release time		Depending on drop-out time setting
Example time delay: Relay TDE4N-UN 72-230 VDC Lr 1.9 s Accuracy $\pm 0.5\%$ : time delay after set in factory is for example 1.91 s (worst case situation)  Actual situation: - Supply voltage 57.6 VDC $\Rightarrow$ 20 % different to lower limit Unom range $\Rightarrow$ time variation $20 \times 0.1\% = 2\%$ - Ambient temperature +60 °C $\Rightarrow$ 40 degrees different compared to 20 °C $\Rightarrow$ time variation $40 \times 0.02 = 0.8\%$ Real delay time: $1.91 \text{ s} \pm 0.5\% \pm 50 \text{ ms}$ (repeatability) $\pm 2\%$ (voltage variation) $\pm 0.8\%$ (temperature variation) = $1.915 \text{ s} \pm 3.3\%$ In this case every actual time delay will be between 1.85 s and 1.98 s.		

#### Remarks:

- Inside the TDE4N is a bistable relay controlled by electronics; the relay can stay in energized mode after removing the control voltage in case the electronics are damaged (e.g. due to a power surge)
- For safety-critical applications we recommend the TDBE4 relay, which doesn't use a bistable relay inside

### Coil characteristics

Minimum operate pulse time	100 ms
Operating voltage range	0.7-1.25 Unom
Guaranteed drop-out voltage	6 V (24-60 V version), 23 V (72-230 V / 72-140 V version)
Nominal current	< 3 mA (24-60 V version), < 2 mA (72-230 V / 72-140 V version)
Inrush current (< 100 ms)	< 750 mA (24-60 V version), < 350 mA (72-230 V / 72-140 V version)
Reset internal timer when delay-off is activated	
- Minimum reset pulse, t <sub>reset</sub> , adjustable	0.1 % of time range + 20 ms
- Minimum reset pulse, t <sub>reset</sub> , fixed	0.2 % of time range + 20 ms

Type	Unom (VDC)	Umin (VDC)	Umax (VDC)
TDE4N-UN	24-60	16.8	75
	72-230	50.4	287.5
With option Q:	72-140	50.4	175

#### Remarks:

- Umin is the must-operate voltage at which the relay has picked up in all circumstances (worst-case situation), in practice the relay picks up at a lower voltage

## Timer relay TDE4N-UN

### Contact characteristics

Contact configuration		4 C/O
Peak inrush current	NF F 62-002	200 A (withstand > 10 x 200 A @ 10 ms, 1 min) 80 A (withstand > 10 x 80 A @ 200 ms, 1 min) 40 A (withstand > 10 x 40 A @ 500 ms, 1 min) 30 A (withstand > 10 x 30 A @ 1000 ms, 1 min)
Maximum continuous current		10 A
Maximum switching voltage		250 VDC, 440 VAC
Minimum switching voltage*		5 V
Minimum switching current*		1 mA
Maximum breaking capacity (> 50.000 operations)		110 VDC, 10 A (resistive load) 72 VDC, 5 A (L/R ≤ 40 ms) 110 VDC, 0.5 A (L/R ≤ 40 ms)
Contact resistance		≤ 15 mΩ (initial)
Material		Ag standard (optional AgSnO <sub>2</sub> , Au on Ag)
Contact gap		0.7 mm
Contact force		> 200 mN

\* Standard silver contacts tested in lab conditions. However we strongly advise to always use gold plated contacts when switching very low currents, as long time reliable operation depends also on switching frequency and environmental conditions. Take recommendations for long time reliability on page 11 into account.

### Contact reliability according IEC 60947-5-4

Contact switching load	Contact material	Failure rate $\lambda_c^*$	Mean number of operating cycles to contact failure $m_c^*$
1 mA, 5 VDC resistive	Gold (option E)	$5 \times 10^{-8}$	20.000.000
5 mA, 24 VDC resistive	Gold (option E)	$4 \times 10^{-8}$	25.000.000
10 mA, 50 VDC resistive	Silver (standard)	$2 \times 10^{-8}$	50.000.000

\*at confidence level 90%

Note: tested in laboratory environment at ambient temperature 20 °C. To underline the reliability of low current switching in parallel a 1 mA / 5 V test was done using standard silver contacts, resulting in the same reliability. But since real train conditions are far different from lab conditions we strongly advise gold plated contacts for such low contact ratings. Take recommendations for long time reliability on page 11 into account.

### Electrical characteristics

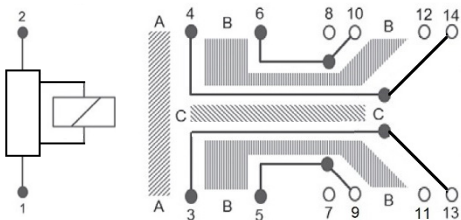
Dielectric strength	Pole-pole Cont-coil Open contacts	4 kV, 50 Hz, 1 min 2.5 kV, 50 Hz, 1 min 2.5 kV; 50 Hz; 1 min		
Clearance and creepage according IEC 60664-1 / EN 50124-2				
				
Section	Clearance	Creepage	Material group	Unom*
A	≥ 4.0 mm	≥ 4.0 mm	I (CTI600)	≤ 450 V
B	≥ 3.0 mm	≥ 3.0 mm	I (CTI600)	≤ 300 V
C	≥ 6.1 mm	≥ 6.1 mm	I (CTI600)	≤ 696 V
*For basic insulation, PD2 and OV3				
Pulse withstanding	IEC 60255-5	5 kV (1.2/50 μs)		
Insulation resistance	EN 50155	> 20 MΩ (test voltage 500 VDC)		
EMC	EN 50121-3-2	Compliant		

## Timer relay TDE4N-UN

### Mechanical characteristics

Torque value screw to lock knob	0.2-0.4 Nm
---------------------------------	------------

### Environmental characteristics

Vibration	IEC 61373, Category I, Class B, Body mounted
Shock	IEC 61373, Category I, Class B, Body mounted
Operating temperature	-40 °C...+70 °C
Operating temperature class	OT4
Humidity	93%
Maximum altitude	2000 meter. Higher altitudes are possible but have consequences mentioned in IEC 60664 (for example 5000 meter with bigger clearance distance)
Salt mist	IEC 60068-2-11, class ST4
Dry heat	IEC 60068-2-2 test Be
Damp heat	IEC 60068-2-30, Test method Db variant 2
Protection	IEC 60529, IP40 (relay on socket) (with option K: IP50)
Fire & smoke	NF F 16-101, NF F 16-102, EN 45545-2: HL3 for requirements R22, R23, R26
Insulation materials	Cover: polycarbonate Base: nylon
Natural cooling or forced ventilation constraints for the equipment	None: no extra measures necessary, relays can be mounted tightly together to save space
REACH: Registration, Evaluation, Authorisation and Restriction of Chemicals	European Regulation No 1907/2006

### RAMS features

Life class	L4 (Useful life 20 years, take electrical life cycle curves into account)
Repairability	Non-repairable
Maintenance instructions	See inspection/maintenance on page 12
Reliability / lifetime Mechanical lifetime  Low energy electrical lifetime High energy electrical lifetime	> 30 million operations, maximum switching frequency 1 Hz (1 million operations at -40 °C) 5 million operations, maximum switching frequency 1 Hz See life cycle curves on page 8
Storage precautions	Storage temperature: -50 °C...+85 °C Store in original packaging Silicon free environment

## Timer relay TDE4N-UN

### Product labeling

Part number identification	Part number mentioned on top side relay
Serial number identification	Serial number mentioned on top side relay Serial number = Lot number + year + week + reference number
Data matrix code	According GS1 standard, placed on top side relay 01 Global Trade Item Number 240 Part number 21 Serial number Example: 011234567890123240123456789211234562209001
Revision index identification	Linked to serial number
Terminals	Identification on bottom plate relay Relay to be used with Mors Smitt relay sockets which have clear terminal identification on each socket

### Railway compliancy

EN 50155: 2017	Railway applications - Rolling stock - Electronic equipment
IEC 60571: 2012	Railway applications - Electronic equipment used on rolling stock
IEC 60947-5-1: 2016 / IEC 60947-5-4: 2012	Low-voltage switchgear and controlgear
IEC 61373: 2010	Railway applications - Rolling stock equipment - Shock and vibration tests
EN 50121-3-2: 2016	Railway applications - Electromagnetic compatibility
NF F16-101/102	Railway rolling stock - Fire behavior
EN 45545-2: 2015	Railway applications - Fire protection on railway vehicles Part 2: Requirements for fire behavior of materials and components

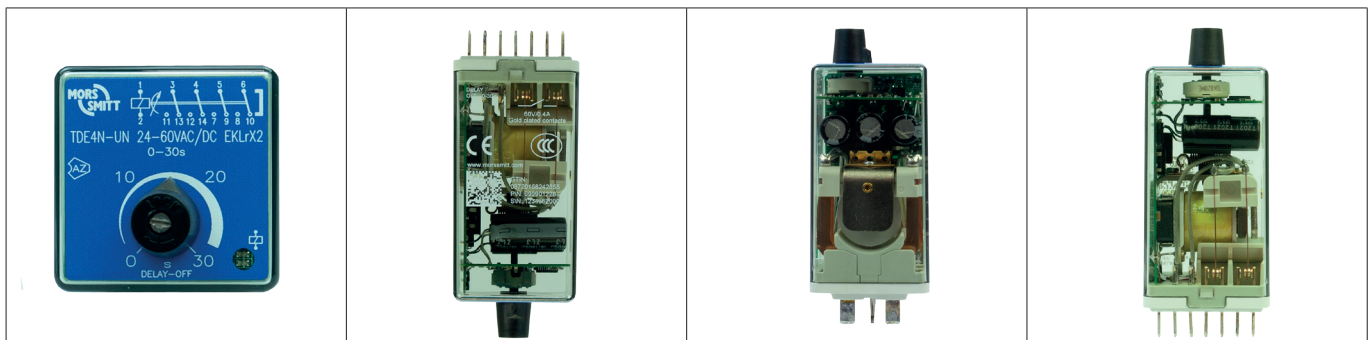

## Timer relay TDE4N-UN

### Options

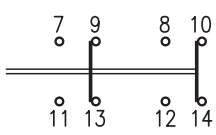
Code	Description	Remark	Cannot be combined with:
Standard options:			
E*	Au; Gold plated contacts (10 µm)		M
K	Extra dust protection	IP50 Cat 2 for the relays mounted in a Mors Smitt socket. Application PD1/PD2 and contact load > 0.5 A.	
Lg**	Green LED indicator		
Lr**	Red LED indicator		
Q	Double zener diode over coil	Only for coil voltages 24-60 VDC and 72-140 VDC (special range for option Q)	X2
Y	Double make/double break contacts, contact gap 1.4 mm	2 C/O DM/DB 	
Keying	Coil coding relay	Also order socket with keying	
Special options:			
M	AgSnO <sub>2</sub> ; "non-weldable" contacts, used for capacitive loads e.g. LED lighting	Icontact > 100 mA	E
X2	AC/DC coil		Q

#### \* Gold plated contacts characteristics

Material	Ag, 10 µm gold plated
Maximum switching voltage	60 V (higher voltages may be possible, contact Mors Smitt for more information)
Maximum switching current	400 mA (at higher rate gold will evaporate, then the standard silver contact rating of minimum 10 mA and 12 V is valid)
Minimum switching voltage	5 V
Minimum switching current	1 mA

\*\* Lg or Lr must be selected in the ordering scheme to have the correct LED color

Remark: For application support or technical product support, contact your local Mors Smitt sales office (see contact details on last page).

## Electrical life expectancy

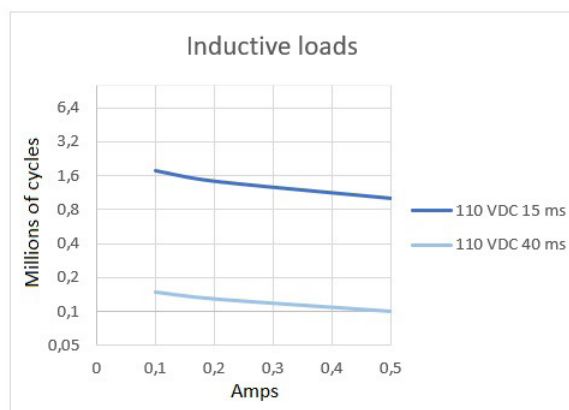
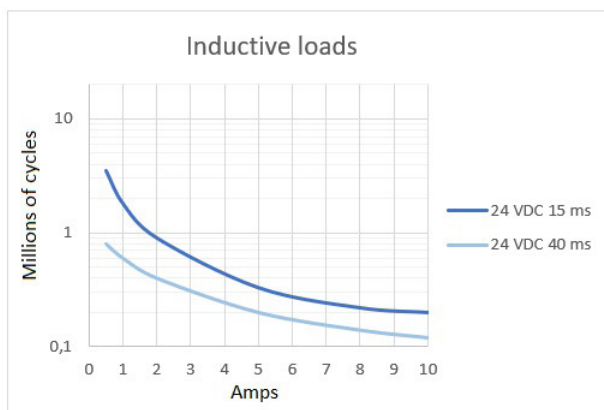
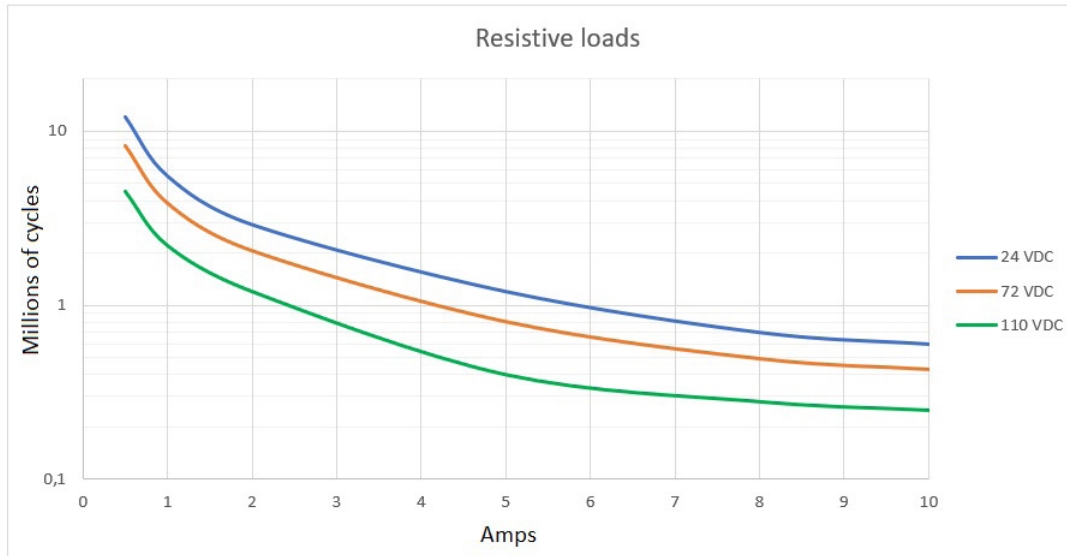

By connecting 2 contacts in series the DC current breaking capacity is increased by 50 %. Electrical lifetime is tested under laboratory conditions with switching frequency 0.33 Hz.

Note: The actual electrical lifetime in the application is affected by the switching frequency, type of contact (N/O or N/C), environmental conditions, etc.

For highly inductive loads Mors Smitt A400/B400 relays with standard double make double break contacts are the optimal solution.

## Self-cleaning contacts

Each contact attracts organic molecules. When the surface is loaded with a voltage, like a relay contact, the attracting force is even higher. Therefore on each contact surface there is organic "pollution".

Mors Smitt relays are designed to self-clean during switching of the contacts:

1. Mechanical wiping action: the "pollution" is swept aside.  
The movement of opposing contacts when they make contact: this wiping action cleans the surface of both contacts. Mors Smitt relays are designed for optimal wiping action: enough to clean the surface and not too much to prevent contact wear.
2. Electrical cleaning: the "pollution" is burnt away.  
A current at sufficient level will evaporate organic "pollution". When switching loads (typically of a current >100 mA), the "pollution" is totally burnt away and a clean contact surface is available.

This results in reliable contact operation without interference due to contact pollution.



**Timer relay**  
**TDE4N-UN**
**Mounting possibilities/sockets**

**Surface/wall mounting**

338000302	V22BR	Screw socket, wall mount, front connection (9 mm terminals)
338000580	V23	Screw socket, wall mount, front connection (7.5 mm terminals)
338000610	V29	Spring clamp socket, wall mount, front dual connection (2.5 mm <sup>2</sup> )

**Rail mounting**

338000580	V23	Screw socket, rail mount, front connection (7.5 mm terminals)
338000402	V23BR	Screw socket, rail mount, front connection (9 mm terminals)
338000610	V29	Spring clamp socket, rail mount, front dual connection (2.5 mm <sup>2</sup> )

**Panel/flush mounting**

338100100	V3	Solder tag socket, panel mount, rear connection
328400100	V26	Crimp contact socket, panel mount, rear connection, A260 crimp contact
338000560	V31	Faston connection socket, rear dual connection (4.8 x 0.8 mm)
338000670	V33	Push-in terminal socket, panel mount, rear dual connection (3.3 mm <sup>2</sup> )

**PCB mounting**

338000561	V32	PCB soldering socket
-----------	-----	----------------------

No external retaining clip needed as the 'snap-lock' will hold the relay into the socket under all circumstances and mounting directions (according shock & vibration requirements IEC 61373, Category I, Class B, Body mounted). If regulations require external retaining clips, these are available as well.

For more details see datasheets of the sockets on [www.morssmitt.com](http://www.morssmitt.com)

## Timer relay TDE4N-UN

### Mechanical keying relay and socket (optional)

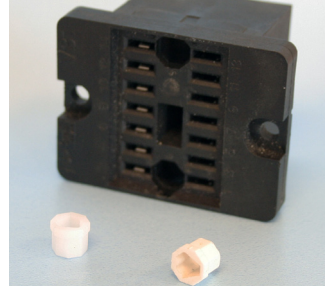

#### Function:

- To prevent wrong installation
- To prevent damage to equipment
- To prevent unsafe situations

Using keyed relays and sockets prevents a relay is inserted in a wrong socket. For example it prevents that a 24 VDC relay is put in a 110 VDC circuit. Positive discrimination is possible per different function, coil voltage, timing, monitoring, safety and non-safety.

The D relay keying option provides  $8 \times 8 = 64$  possibilities. Upon ordering the customer simply indicates the need for the optional keying. Mors Smitt will assign a code to the relay and fix the pins into the relay. The sockets are supplied with loose key receptacles. Inserting the keys into the socket is very simple and self explanatory.

Remark: Sockets and relay shown are examples.

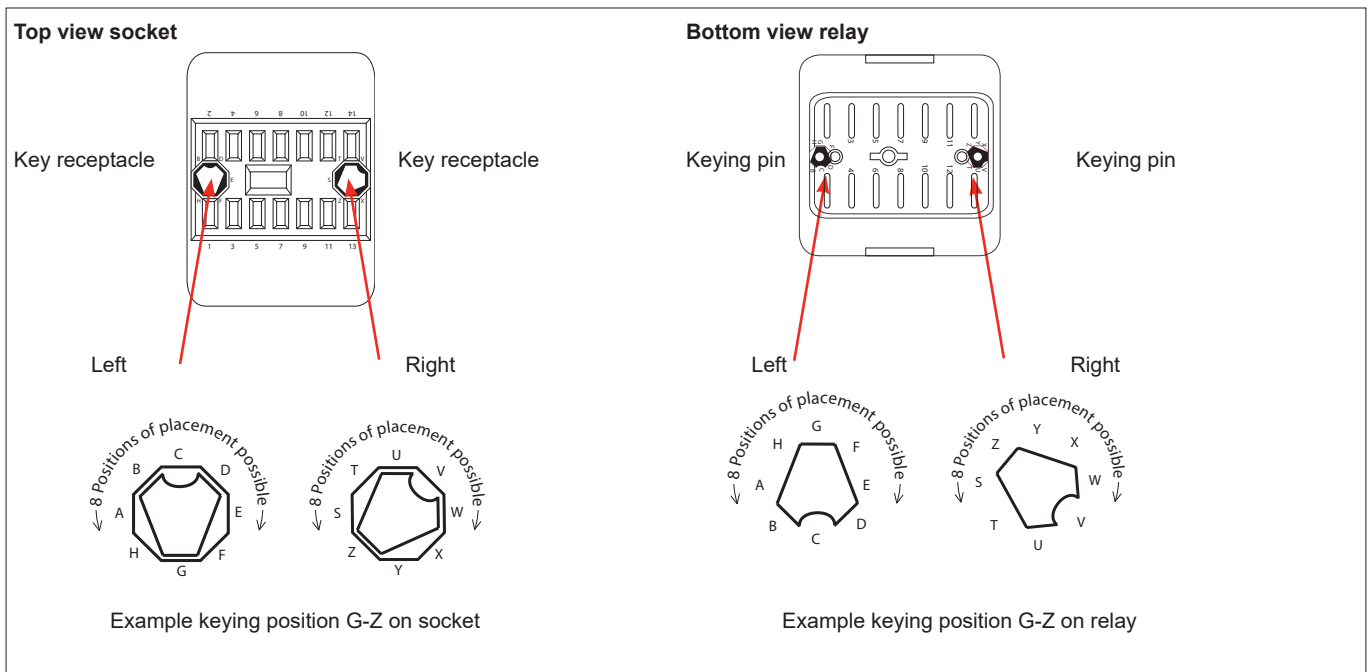

### Keying codes

	Coil voltage code	
	24-60 VDC	72-230 VDC / 72-140 VDC
Silver contacts (standard)	AS	AU
Gold contacts (option E)	DT	AZ
Silver tin oxide (option M)	GT	GV

## Timer relay TDE4N-UN

### Important for relay selection and operation

Make sure the relay is suitable for the application. For critical applications (for example: green loop applications) relays should be checked for proper operation during periodic inspection.

#### Contact switching current

Each relay has a range of switching currents in which it performs optimally: the sweet spot. As switching currents are decreasing in field applications, the TDE4N-UN relay has an improved sweet spot compared to its predecessors.

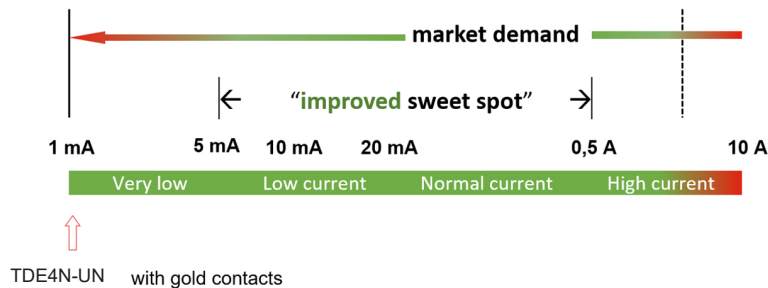

#### Recommendations for long time contact reliability

For relays to enable failure free performance over a very long operational time, it is important to create the right circumstances. In any relay, contact usage and atmospheric conditions influence the contact surface. To counter this effect it is common practice to use a safety factor of  $> 2$  to ensure long time contact reliability.

Therefore for long time contact reliability we recommend:

- Silver contacts: a minimum contact current of 20 mA per contact
- Gold contacts: a minimum contact current of 10 mA per contact
- Double Make Double Break contacts: a minimum contact current of 40 mA per contact
- When low currents are switched not frequently, e.g. 10 mA once a day, it is advised (next to gold plated contacts) to put similar contacts within the same relay in parallel
- With higher load switching, e.g. 110 VDC and  $> 1$  A, put relay contacts in series
- Rule of thumb: any relay works best with switching currents  $> 20$  mA in DC environment when frequently switched. When not switched frequently a higher switching current like 50 mA is better for a long reliable operational time
- When switching capacitive loads (e.g. LED lighting) always use silver tin oxide contacts (minimal contact current 100 mA)
- Check relays regularly, for example with the Mors Smitt Portable Relay Tester and visually through the transparent cover

### Instructions for use

#### Installation

Before installation or working on the relay: disconnect the power supply first (no hot swapping)! Install socket and connect wiring according to the terminal identification. Plug relay into the socket ensuring there is no gap between the bottom of relay and the socket. Reverse installation into the socket is not possible due to the mechanical blocking snap-lock feature. Check to ensure that the coil connection polarity is not reversed. Relays can be mounted tightly together to save space. When rail mounting is used, always mount the socket in the direction of the UP arrow, to have proper fixation of the socket on the rail. Torque value screw to lock knob: 0.2-0.4 Nm

#### Warning!

- Never use silicon in the proximity of the relays
- Do not use the relay in the presence of flammable gas as the arc generated from switching could cause ignition
- To remove relays from the socket, employ up and down lever movements. Sideway movement may cause damage to the coil wires

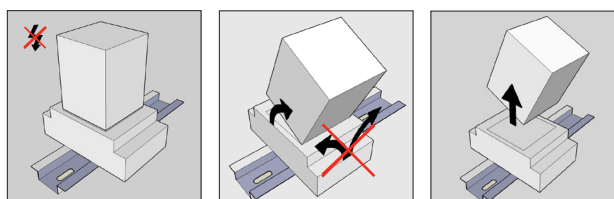

- Relays should never be swapped to other circuit positions when taken out of its socket for inspection or fault finding, always place it back into the original position to prevent contact resistance problems. Contact resistance problems can be created when swapping relays between different circuit loads due the contact wear/condition having changed during its operational life.

## Timer relay TDE4N-UN

### Operation

After installation always apply the rated voltage to the coil to check correct operation. Long term storage may corrode the silver on the relay pins. When plugging the relay into the socket, the female bifurcated or trifurcated receivers will automatically cut through the corrosion on the pins and guarantee a reliable connection.

Before actual use of relays, it is advised to switch the load several times with the contacts. The contacts will both be electrically and mechanically cleaned due to the positive wiping action. Sometimes a contact can build up increased contact resistance ( $\leq 15 \text{ m}\Omega$  when new). When using silver contacts one can clean the contact by switching a contact load a few times using  $>24 \text{ VDC}$  &  $\sim 2\text{A}$ . Increased contact resistance is not always problematic, as it depends on circuit conditions. In general a contact resistance of  $1 \Omega$  is no problem, consult Mors Smitt for more information.

Condensation inside the relay housing can occur when it moves from a warm (and humid) environment to a colder environment. This is a normal phenomenon and will not affect the function of the relay. Materials in the relay have no hygroscopic properties.

### Inspection / maintenance

Correct operation of the relay can easily be checked as the transparent cover provides good visibility of the moving contacts. If the relay does not seem to operate correctly, check for presence of the appropriate coil voltage and polarity using a suitable multimeter. If a LED is fitted, it indicates voltage presence to the coil. If coil voltage is present, but the relay does not operate, a short circuit of the suppression diode is possible (this may have been caused due to reversed coil connection).

Relays can easily be tested with the Mors Smitt Relay Tester. More information on: [www.morssmitt.com](http://www.morssmitt.com).

If the relay doesn't work after inspection, replace the relay with a similar model. Do not attempt to open the relay cover or try to repair. Contacts are calibrated and in balance, touching can affect proper operation. Also resoldering may affect correct operation. Since 2009 relays have tamper proof seals fitted and once broken, warranty is void.

Most relay defects are caused by installation faults such as overvoltage, spikes/transients, reversed coil connection, high/short current far exceeding the relay specifications. When returning the relays for investigation, please provide all information on the RMA form. Send defective relays back to the manufacturer for repair or replacement. Normal wear and tear or external causes are excluded from warranty.

RMA procedure see [www.morssmitt.com](http://www.morssmitt.com)

## Timer relay TDE4N-UN

### Ordering scheme

TDE4N-UN								code		
Coil voltages	24-60 VDC									
	72-230 VDC									
	72-140 VDC								Cannot be combined with	
Options (add as many options as needed)		E						Gold plated contacts	M	
		K						Extra dust protection, IP50		
		Lg*						Green LED indicator*		
*a LED indicator is MANDATORY		Lr*						Red LED indicator*		
		Q						Double zener diode	X2	
		Y						Double make / double break contacts		
Special options (minimum order quantity: 20)		M						AgSnO <sub>2</sub> contacts, highly resistant to welding	E	
		X2						Coil for both DC and AC	Q	
Time ranges delay-off			0 - 1 s							
			0 - 3 s							
			0 - 6 s							
			0 - 10 s							
			0 - 30 s							
			0 - 60 s							
			0 - 100 s							
			0 - 180 s							
			Fixed							Value between 0-180 s, no knob
Keying code									See table on page 10, leave blank for no keying	

Example: TDE4N-UN 72-230 VDC ELr 0-10s

Description: TDE4N-UN relay, Unom: 72-230 VDC, gold plated contacts, red LED indicator, adjustable delay time 0-10 s, no keying code

Example: TDE4N-UN 24-60 VDC LgY 120s code AS

Description: TDE4N-U relay, Unom: 24-60 VDC, green LED indicator, double make / double break contacts, fixed time delay 120 s, keying code AS

**Timer relay**  
**TDE4N-UN**

---

 **Over 10 million Mors Smitt relays in use in rail transport applications worldwide!**

**Mors Smitt Asia Ltd.**  
26/F, Casey Aberdeen House  
38 Heung Yip Road, Wong Chuk Hang  
Hong Kong  
Tel: +852 2343 555  
sales.msa@wabtec.com

**Mors Smitt France SAS**  
2 Rue de la Mandinière  
72300 Sablé-sur-Sarthe, France  
Tel: +33 (0) 243 92 82 00  
sales.msf@wabtec.com

**Mors Smitt UK**  
Graycar Business Park  
Burton on Trent, DE13 8EN, UK  
Tel: +44 (0)1283 357 263  
sales.msuk@wabtec.com

**Wabtec Netherlands B.V.**  
Darwinstraat 10  
6718 XR Ede, Netherlands  
Tel: +31 (0)88 600 4500  
sales.msbv@wabtec.com

**Mors Smitt Technologies Ltd.**  
1010 Johnson Drive  
Buffalo Grove, IL 60089-6918, USA  
salesmst@wabtec.com

**RMS Mors Smitt**  
19 Southern Court  
Keysborough, VIC 3173, Australia  
Tel: +61 (0)3 8544 1200  
sales.rms@wabtec.com

(c) Copyright 2022

All rights reserved. Nothing from this edition may be multiplied, or made public in any form or manner, either electronically, mechanically, by photocopying, recording, or in any manner, without prior written consent from Mors Smitt. This also applies to accompanying drawings and diagrams. Due to a policy of continuous development Mors Smitt reserves the right to alter the equipment specification and description outlined in this datasheet without prior notice and no part of this publication shall be deemed to be part of any contract for the equipment unless specifically referred to as an inclusion within such contract. Mors Smitt does not warrant that any of the information contained herein is complete, accurate, free from potential errors, or fit for any particular purpose. Mors Smitt does not accept any responsibility arising from any party's use of the information in this document.